

# GUHRING



## Stainless Steels

**Complete solutions from one source**

- drilling from Ø 0.8 mm and up to 80xD drilling depth
- HPC reaming with highest accuracy
- HPC milling with perfect surface finish
- threading tools for every application
- custom made modular tools

### Stainless steels and their attributes

Stainless or acid-resistant steels have a very high chromium content  $> 12\%$ , an excellent resistance against chemically aggressive substances and corrosion. The chromium creates a micro oxygen diffusing chromium dioxide coating on the surface, that prevents in-depth corrosion.

Most stainless steels are from the austenitic group of steels. Next to chromium, nickel is the most important constituent of the structure, often molybdenum is also added to optimise the mechanical characteristics. The range of application of austenitic steels is the food industry, power plants and energy supply, ship building and the petrochemical industry, but increasingly also applications in architecture for wall cladding and roofing. Typical materials are 1.4301 (X5CrNi 18 10 / V2A), 1.4541 (X6CrNiTi 18 10), 1.4571 (X6CrNiMoTi 17 12 2 / V4A) or 1.4311 (X2CrNiN 18 10).



Cover picture and picture above:  
With kind permission of  
Kreyenberg, Norderstedt.



### Properties and attributes when machining

When machining stainless or acid-resistant steels, the following properties should be noted: These materials tend to work harden, are very poor conductors of heat and display a high toughness and shear elongation. The high toughness leads to a very heavy cutting load especially when drilling and when producing threads. In addition, the mechanical properties of stainless or acid-resistant steels produce unfavourable chips that tend to stick and jam.

### Optimal machining and tool selection

Stainless or acid-resistant steels due to their properties and attributes require sharp tools with their back taper and clearance angle configured in such a way that the high elastic deformation does not lead to a jamming of the tool when machining.

High feed rates result in an optimal dissipation of heat via the chips, a very good cooling lubrication - ideally via internal cooling - supports the removal of heat as well as chip evacuation and, in addition, counteracts the work hardening. As coolant we recommend high-performance cutting oil, but at least 8 % soluble oil. In addition, pecking may be necessary during machining.

A relatively low cutting speed should be chosen and can greatly depend on the material composition. Machining tests are paramount for selecting the optimal cutting speed.

Due to the high work load particular attention must be paid to maximum rigidity of the machine as well as the workpiece and tool clamping. Always select the shortest possible tool for your machining task.



### Ratio drills RT 100 VA and RT 100 T

Constant high performance and accuracy in stainless steels is provided by Guhring's Ratio drills RT 100 VA in the diameter range from 3.0 to 20.0 mm for the drilling depths 3xD and 5xD as well as Guhring's Ratio drills RT 100 T in the diameter range from 3.0 to 14.0 mm for the drilling depths 20xD, 25xD, 30xD and 40xD. The geometries, tool materials and coatings of these two Ratio drills is especially adapted for the machining of stainless steels enabling the highest cutting parameters, perfect surface quality and secure chip evacuation especially from deep holes. This is supported by numerous drilling tests and application examples:

#### Selected machining results RT 100 VA

<b>Guhring no.</b>	8511	8511	8611
<b>Diameter</b>	8.0	15.0	6.8
<b>Coating</b>	TiAlN nanoA	TiAlN nanoA	TiAlN nanoA
<b>Material group</b>	stainless steel	stainless steel	stainless steel
<b>Material description</b>	X5CrNi18 10 1.4301	X6CrNiMoTi17-12-2 1.4571	X6CrNiTi1810 1.4541
<b>Drilling depth [mm]</b>	34	58	28
<b>Hole type</b>	through hole	blind hole	blind hole
<b>Cooling</b>	internal	internal	internal
<b>Lubricant</b>	soluble oil	soluble oil	soluble oil
<b>Machine type</b>	machining centre	machining centre	machining centre
<b>v<sub>c</sub> [m/min]</b>	50	90	60
<b>f [mm/rev.]</b>	0.2	0.14	0.1
<b>Tool life [m]</b>	140	63	150

#### Selected machining results RT 100 T

<b>Guhring no.</b>	6511	6512	6513
<b>Diameter</b>	3.5	8.0	5.0
<b>Coating</b>	TiAlN	TiAlN	TiAlN
<b>Material group</b>	stainless steel	stainless steel	stainless steel
<b>Material description</b>	X5CrNi18 10 1.4301	X6CrNiTi1810 1.4541	X6CrNiMoTi17-12-2 1.4571
<b>Drilling depth [mm]</b>	15	210	150
<b>Hole type</b>	through hole	through hole	through hole
<b>Cooling</b>	internal	internal	internal
<b>Lubricant</b>	soluble oil	soluble oil	soluble oil
<b>Machine type</b>	machining centre	machining centre	machining centre
<b>v<sub>c</sub> [m/min]</b>	90	30	35
<b>f [mm/rev.]</b>	0.04	0.08	0.04
<b>Tool life [m]</b>	85	11	18

## Drilling tools for stainless steels

Standard	Type	Shank form	Tool description and application	Drilling depth	Tool material	Surface finish	Diameter range	Guhring no.
<b>RT 100 VA - Ratio drills</b>								
<b>with coolant ducts</b>								
DIN 6537 K	RT 100 VA	HA		3 x D	solid carbide	TiAIN nanoA	3.000 - 20.000	<b>8510</b>
DIN 6537 K	RT 100 VA	HE		3 x D	solid carbide	TiAIN nanoA	3.000 - 20.000	<b>8610</b>
DIN 6537 L	RT 100 VA	HA		5 x D	solid carbide	TiAIN nanoA	3.000 - 20.000	<b>8511</b>
DIN 6537 L	RT 100 VA	HE		5 x D	solid carbide	TiAIN nanoA	3.000 - 20.000	<b>8611</b>
<b>RT 100 T - Ratio drills</b>								
<b>with coolant ducts</b>								
Guhring standard	RT 100 T	HA		20 x D	solid carbide	TiAIN	3.00 - 14.00	<b>6511</b>
Guhring standard	RT 100 T	HA		25 x D	solid carbide	TiAIN	3.00 - 12.00	<b>6512</b>
Guhring standard	RT 100 T	HA		30 x D	solid carbide	TiAIN	3.00 - 10.00	<b>6513</b>
Guhring standard	RT 100 T	HA		40 x D	solid carbide	TiAIN	3.00 - 8.00	<b>6514</b>



### Solid carbide micro-precision drills

For especially small holes in stainless steels Guhring offers solid carbide micro-precision drills with diameters between 0.8 and 3.0 mm. They are available without internal cooling for the drilling depths 4xD and 7xD as well as with internal cooling for the drilling depths 8xD and 15xD.

### Selected solid carbide micro-precision drill machining results

<b>Guhring no.</b>	6408	6412	6408
<b>Diameter</b>	2.6 mm	2.1 mm	1.4 mm
<b>Coating</b>	TiAlN SuperA	TiAlN SuperA	TiAlN SuperA
<b>Material group</b>	stainless steel	stainless steel	stainless steel
<b>Material description</b>	105CrMo17 1.4125	X6CrNiTi18 10 1.4301	X6CrNiTi18 10 1.4301
<b>Drilling depth</b>	8xD	15xD	8xD
<b>Hole type</b>	blind hole	blind hole	blind hole
<b>Cooling</b>	internal 100 bar	internal 80 bar	internal 80 bar
<b>Lubricant</b>	neat oil	soluble oil	soluble oil
<b>Machine type</b>	machining centre	machining centre	machining centre
<b>v<sub>c</sub> [m/min]</b>	53	60	60
<b>f [mm/rev.]</b>	0.06	0.03	0.021
<b>Tool life [m]</b>	500 parts, end of tool life not reached!	60	50

### GU 500 high-speed steel drills







For smaller batch sizes as well as unstable machine conditions the application of HSCO GU 500 drills is recommended. They have a reinforced straight shank and are available in short or extra short lengths.

GU 500 high speed drills achieve excellent machining results in stainless steels:

### GU 500 selected machining results

<b>Guhring no.</b>	511	511	512
<b>Diameter</b>	5.56	6.8	6.0
<b>Coating</b>	TiN	TiN	TiN
<b>Material group</b>	stainless steel	stainless steel	stainless steel
<b>Material description</b>	XCrNi18-10/ 1.4304	XCrNi18-10/ 1.4304	X6CrNiMoTi17-12-2 1.4571
<b>Drilling depth [mm]</b>	43	30.8	22.0
<b>Hole type</b>	through hole	through hole	blind hole
<b>Cooling</b>	external	external	external
<b>Lubricant</b>	soluble oil	soluble oil	soluble oil
<b>Machine type</b>	machining centre	machining centre	machining centre
<b>v<sub>c</sub> [m/min]</b>	40	10	14
<b>f [mm/rev.]</b>	0.1	0.08	0.1
<b>Tool life [m]</b>	9	30.5	5

## Drilling tools for stainless steels

Standard	Type	Shank form	Tool description and application	Drilling depth	Tool material	Surface finish	Diameter range	Guhring no.
<b>Solid carbide micro-precision drills</b>								
<b>without coolant ducts</b>								
Guhring standard	N	HA		4 x D	<b>solid carbide</b>	TiAlN Super A	0.800 - 3.000	<b>6400</b>
Guhring standard	N	HA		7 x D	<b>solid carbide</b>	TiAlN Super A	0.800 - 3.000	<b>6401</b>
<b>Solid carbide micro-precision drills</b>								
<b>with coolant ducts</b>								
Guhring standard	N	HA		8 x D	<b>solid carbide</b>	TiAlN Super A	1.400 - 3.000	<b>6408</b>
Guhring standard	N	HA		15 x D	<b>solid carbide</b>	TiAlN Super A	1.400 - 3.000	<b>6412</b>
<b>GU 500</b>								
<b>twist drills with reinforced shank</b>								
Guhring standard	GU 500			3 x D	<b>HSCO</b>	TiN	3.00 - 14.00	<b>512</b>
Guhring standard	GU 500			5 x D	<b>HSCO</b>	TiN	3.00 - 14.00	<b>511</b>

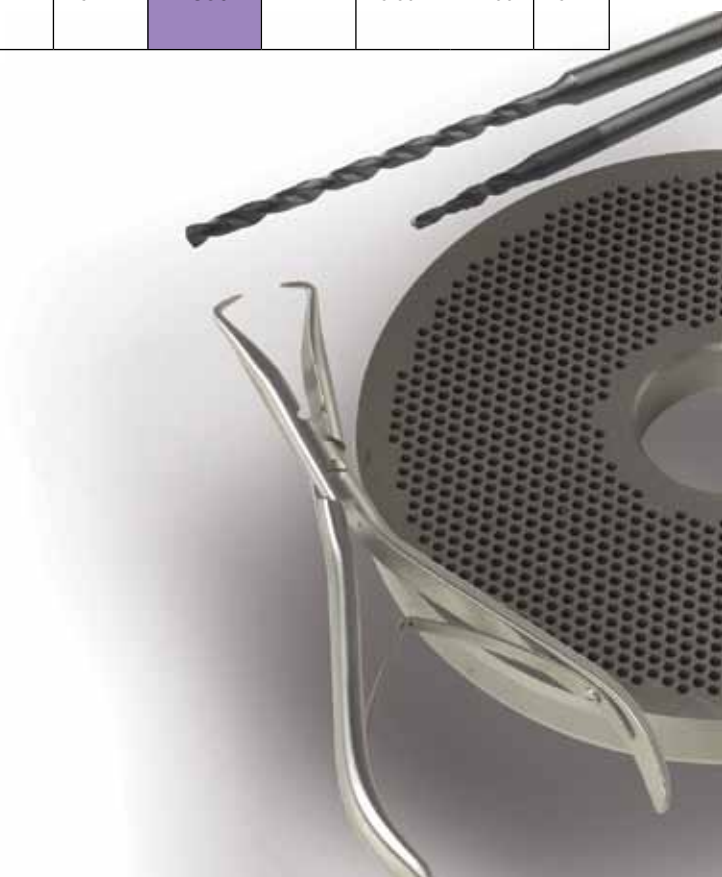

### EB 80 and EB 100 single-flute gun drills

Gühring provides single-flute gun drills type EB 80 and EB 100 ex-stock especially for close tolerances or for primarily deep holes and especially for the machining of high-alloyed and stainless steels. Thanks to their special carbide grade, geometry and coating they achieve long tool life in stainless steels as the machining results listed below demonstrate.

#### Selected machining results EB 80

#### EB 100

<b>Gühring no.</b>	5640	5641	5637
<b>Diameter</b>	6.0	10.0	2.5
<b>Coating</b>	TiCN	TiCN	SuperA
<b>Material group</b>	stainless steel	stainless steel	stainless steel
<b>Material description</b>	X5CrNi1810 1.4301	X6CrNiTi181C 1.4541	X620CrNiMoTi17-12-2 1.4571
<b>Drilling depth [mm]</b>	175	380	110
<b>Hole type</b>	through hole	blind hole	blind hole
<b>Cooling</b>	internal	internal	internal
<b>Lubricant</b>	soluble oil	soluble oil	soluble oil
<b>Machine type</b>	machining centre	machining centre	machining centre
<b><math>v_c</math> [m/min]</b>	55	40	45
<b><math>f</math> [mm/rev.]</b>	0.014	0.016	0.008
<b>Tool life [m]</b>	3.5	2.7	2.1





## Drilling tools for stainless steels

Standard	Type	Tool description and application	Flute length (mm)/ Drilling depth	Tool material	Surface finish	Diameter range	Guhring no.
<b>Gun drills EB80</b>							
<b>with coolant ducts</b>							
Guhring standard	EB 80		20 x D	Solid carbide	TiCN	4.000 - 12.000	5639
Guhring standard	EB 80		30 x D	Solid carbide	TiCN	4.000 - 12.000	5640
Guhring standard	EB 80		40 x D	Solid carbide	TiCN	4.000 - 12.000	5641
Guhring standard	EB 80		80 x D	Solid carbide	TiCN	4.950 - 11.950	5642
<b>Gun drills EB100</b>							
<b>with coolant ducts</b>							
Guhring standard	EB 100		45.00	Solid carbide	TiAlN SuperA	2.000 - 3.200	5632
Guhring standard	EB 100		80.00	Solid carbide	TiAlN SuperA	2.000 - 5.000	5633
Guhring standard	EB 100		120.00	Solid carbide	TiAlN SuperA	2.000 - 5.000	5637
Guhring standard	EB 100		160.00	Solid carbide	TiAlN SuperA	2.000 - 8.000	5638

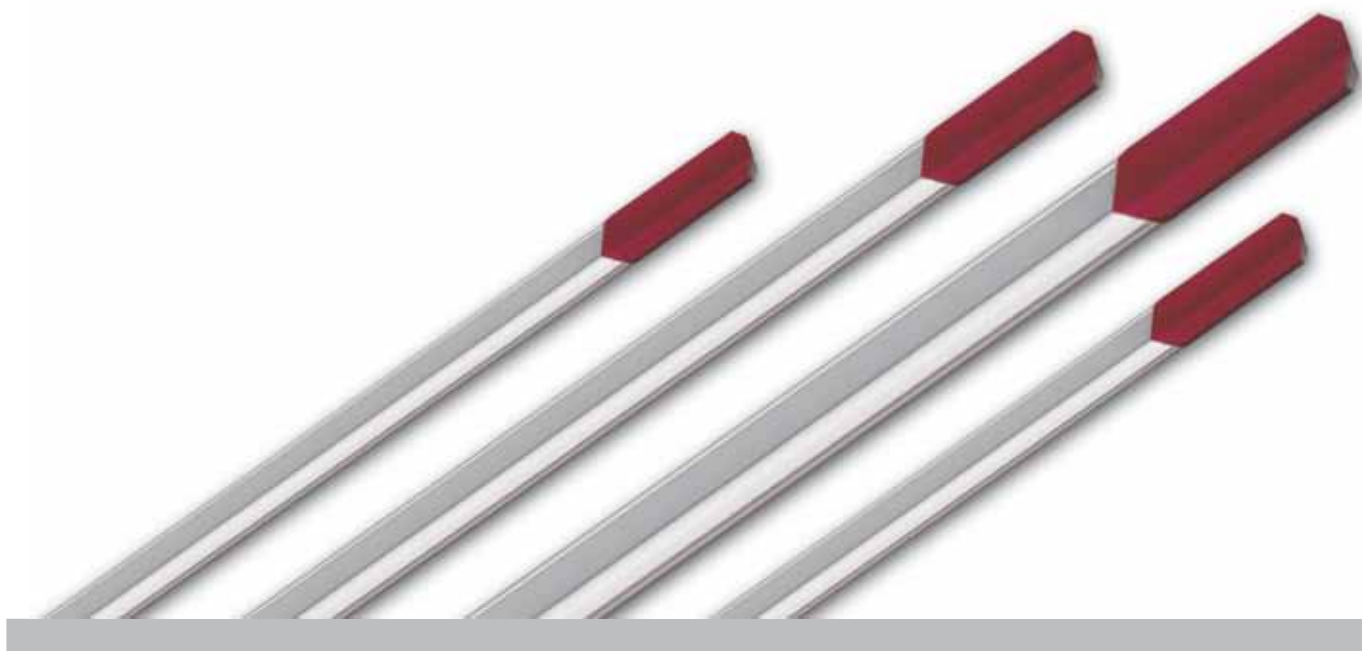

### HR 500 high-performance reamers and solid carbide NC-reamers

High-performance and extreme accuracy are the features of Guhring's HR 500 reamers and solid carbide NC-reamers. HR 500 high-performance reamers excel as solid carbide tools in the diameter range up to 20.00 mm with highest performance levels. They are also available as carbide-tipped tools in the diameter range from 22.0 to 40.0 mm, so the tool material is optimally adapted to the machining task.

Guhring's NC-reamers are designed to satisfy the high quality demands in the production arena and are designed for accurate clamping in hydraulic chucks and shrink fit chucks.

### HR 500 selected machining results









<b>Guhring no.</b>	1686	1685	1685	1685
<b>Diameter</b>	10.0	16.0	5.0	7.0
<b>Coating</b>	TiAlN	TiAlN	TiAlN	TiAlN
<b>Material group</b>	stainless steel	stainless steel	stainless steel	stainless steel
<b>Material description</b>	X6CrNiMoTi17 12 2 1.4571	X20CrNi17 2 1.4057	X10CrNiS18 9 1.4305	X1CrNiMoN25 25 2 1.4465
<b>Drilling depth [mm]</b>	25.0	19.0	7.5	65
<b>Hole type</b>	through hole	blind hole	blind hole	blind hole
<b>Cooling</b>	internal	internal	external	internal
<b>Lubricant</b>	soluble oil	soluble oil	soluble oil	neat oil
<b>Machine type</b>	machining centre	machining centre	machining centre	turning centre
<b><math>v_c</math> [m/min]</b>	80	100	60	60
<b><math>f_z</math> [mm]</b>	0.13	0.25	0.2	0.13
<b>Tool life [m]</b>	25	28.5	12	195

### Solid carbide NC-reamers selected machining results

<b>Guhring no.</b>	1449
<b>Diameter</b>	7.0
<b>Coating</b>	TiN
<b>Material group</b>	stainless steel
<b>Material description</b>	X6CrNiMoTi17 12 2 1.4571
<b>Drilling depth [mm]</b>	20,0
<b>Hole type</b>	through hole
<b>Cooling</b>	external
<b>Lubricant</b>	soluble oil
<b>Machine type</b>	machining centre
<b><math>v_c</math> [m/min]</b>	6
<b><math>f_z</math> [mm]</b>	0.025
<b>Tool life [m]</b>	7.0



## Reaming tools for stainless steels

Standard	Type	Shank form	Tool description and application	Tool material	Surface finish	Diameter range	Gühring no.
<b>HR 500 S</b>							
<b>for blind holes</b>							
Gühring standard	HR 500 S	straight h6		<b>solid carbide</b>	TiAlN	4.000 - 20.000	<b>1685</b>
Gühring standard	HR 500 S	straight h6		<b>solid carbide</b>	TiAlN	3.970 - 12.030	<b>1675</b>
<b>HR 500 D</b>							
<b>for through holes</b>							
Gühring standard	HR 500 D	straight h6		<b>solid carbide</b>	TiAlN	4.000 - 20.000	<b>1686</b>
Gühring standard	HR 500 D	straight h6		<b>solid carbide</b>	TiAlN	3.970 - 12.030	<b>1676</b>
<b>HR 500 GS</b>							
<b>for blind holes</b>							
Gühring standard	HR 500 GS	straight h6		<b>carbide</b>	TiAlN	22.000 - 40.000	<b>1680</b>
<b>HR 500 GD</b>							
<b>for through holes</b>							
Gühring standard	HR 500 GD	straight h6		<b>carbide</b>	TiAlN	22.000 - 40.000	<b>1681</b>
<b>Solid carbide NC-reamers</b>							
<b>with extremely unequal spacing</b>							
Gühring standard		straight h6		<b>solid carbide</b>	bright	0.980 - 12.050	<b>1427</b>
Gühring standard		straight h6		<b>solid carbide</b>	bright	3.000 - 12.000	<b>1449</b>

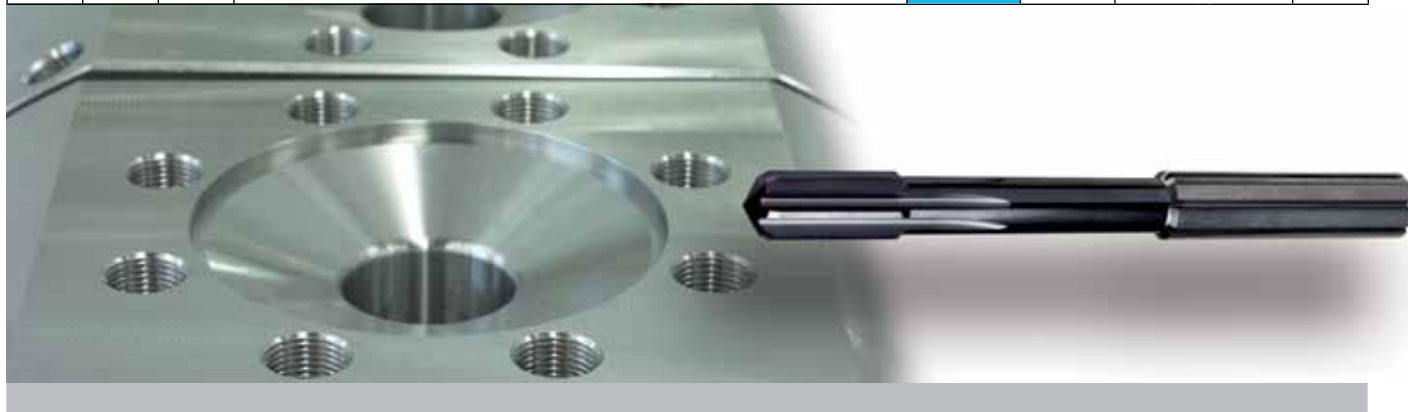

### Ratio end mills RF 100 VA

RF 100 high-performance end mills excel with different spiral angles, resulting in a vibration-free cut. With the unequal helix, a considerably better surface quality is achieved on finishing operations and clearly higher feed rates can be achieved with slot drilling and rough milling.

With many applications the complete milling process can be covered with a RF 100, generating a considerable cost advantage in addition to an increase in tool life and dimensional accuracy of the workpiece.

In combination with the newly developed roughing geometry RF 100 VA/NF milling cutters enable a drastic increase in tool life compared to conventional roughing end mills with round or flat knuckle-type teeth. At the same time the surface quality improves to a peak-to-valley depth of approximately  $R_a = 2-3\mu\text{m}$ , making finishing operations in many cases unnecessary. In addition, the new design reduces power consumption in comparison to conventional RF 100 end mills, allowing application in unstable conditions and on less powerful machines.





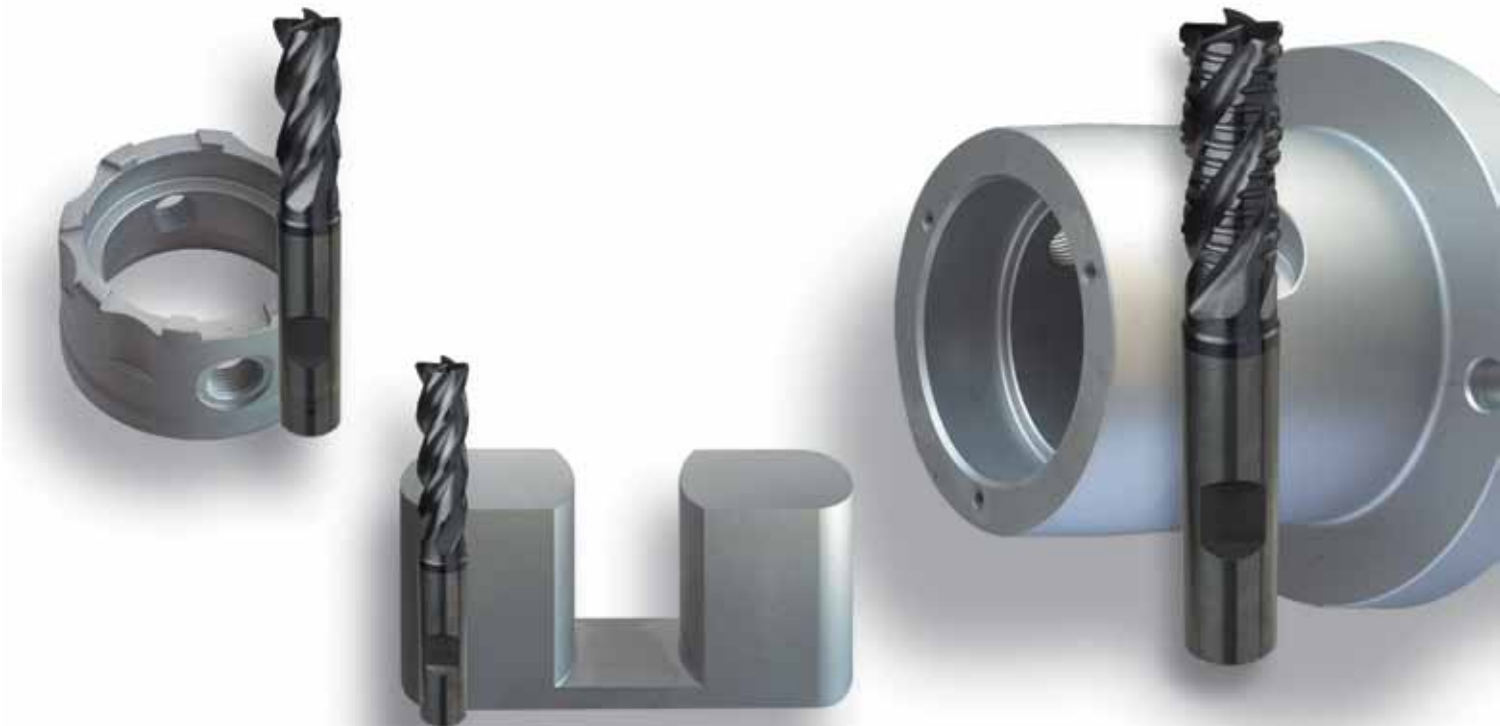





### RF 100 VA and RF 100 VA/NF selected machining results

Guhring no.	3805	3803	3080	3718	3803
Type	RF 100 VA	RF 100 VA	RF 100 VA	RF 100 VA/NF	RF 100 VA
Diameter	12.0	12.0	12.7	12.0	12.0
Coating	TiAlN nanoA	TiAlN nanoA	TiAlN nanoA	TiAlN nanoA	TiAlN nanoA
Material group	stainless steel	stainless steel	stainless steel	stainless steel	special alloy
Material description	X5CrNi13 4 1.4301	X12CrMoS17 1.4104	X6CrNiMoTi17 12 2 1.4571	X10CrNiS18 9 1.4305	Inconel 625
Cutting depth $a_p$ [mm]	6.0	12.0	14.5	18.0	12.0
Cutting width $a_e$ [mm]	3.0	6.0	2.5	12.0	12.0
Milling type	rough milling	rough milling	finish milling	slot drilling	slot drilling
Cooling	external	external	without	external	external
Lubricant	soluble oil	soluble oil		soluble oil	soluble oil
Machine type	machining centre (BT 40)	machining centre (BT 40)	machining centre (BT 50)	machining centre (HSK 100)	machining centre (HSK 63)
$v_c$ [m/min]	113	190	118	72	33
$f_z$ [mm/tooth]	0.084	0.04	0.08	0.065	0.04
Tool life [m]	81	132	45	(126 min.)	(70 min.)





## Milling tools for stainless steels

Standard	Type	Shank form	Tool description and application	Tool material	Surface finish	Diameter range	Gühring no.
<b>Ratio end mills RF 100 VA</b>							
<b>centre cutting</b>							
DIN 6527 K	NH 36°/38°	HA		<b>Solid carbide</b>	TiAlN nanoA	4.000 - 20.000	<b>3804</b>
DIN 6527 K	NH 36°/38°	HB		<b>Solid carbide</b>	TiAlN nanoA	4.000 - 20.000	<b>3805</b>
DIN 6527 L	NH 36°/38°	HA		<b>Solid carbide</b>	TiAlN nanoA	6.000 - 25.000	<b>3800</b>
DIN 6527 L	NH 36°/38°	HB		<b>Solid carbide</b>	TiAlN nanoA	6.000 - 25.000	<b>3803</b>
Gühring standard	NH 36°/38°	HA		<b>Solid carbide</b>	TiAlN nanoA	6.000 - 20.000	<b>3806</b>
Gühring standard	NH 36°/38°	HB		<b>Solid carbide</b>	TiAlN nanoA	6.000 - 20.000	<b>3807</b>
<b>Ratio end mills RF 100 VA/NF</b>							
<b>centre cutting</b>							
DIN 6527 L	NF 36°/38°	HA		<b>Solid carbide</b>	TiAlN nanoA	6.000 - 25.000	<b>3696</b>
DIN 6527 L	NF 36°/38°	HB		<b>Solid carbide</b>	TiAlN nanoA	6.000 - 25.000	<b>3718</b>
Gühring standard	NF 36°/38°	HA		<b>Solid carbide</b>	TiAlN nanoA	6.000 - 20.000	<b>3733</b>
Gühring standard	NF 36°/38°	HB		<b>Solid carbide</b>	TiAlN nanoA	6.000 - 20.000	<b>3885</b>

### Taps, fluteless taps and thread milling cutters

Diversity is the motto of Guhring's threading tools for the machining of stainless steels. The user can find a suitable tool for every machining task in Guhring's wide-ranging threading tool program.

On these pages we are only introducing reference tools for ISO metric threads. Taps, fluteless taps and thread milling cutters are also available for all thread types and tolerance zones. Furthermore, there are alternative tools available with other surface finishes for further thread depths etc. The complete threading tool program can be found in the current threading tool catalogue.

#### Selected machining results for

#### tapping

#### fluteless tapping









<b>Guhring no.</b>	2086	2896	59	761	1139	322	1972
<b>Diameter</b>	M10	M16	M6	M6	M10	M8	M16x1.5
<b>Coating</b>	TiN	TiN	TiN	TiN	TiCN	TiN	TiCN
<b>Material group</b>	stainless steel	stainless steel	stainless steel	stainless steel	stainless steel	stainless steel	stainless steel
<b>Material description</b>	X5CrNi13 4 1.4301	X6CrNiMoTi17 12 2 1.4571	X2CrNiMo17-12-2 1.4404	X2CrNiMo18-14-3 1.4435 Guss	X10CrNiS18 9 1.4305	X5CrNi13 4 1.4301	X6CrNiMoTi17 12 2 1.4571
<b>Thread depth [mm]</b>	21.0	30.0	12.0	15.0	20.0	18.0	16.0
<b>Hole type</b>	through hole	blind hole	blind hole	blind hole	blind hole	blind hole	blind hole
<b>Cooling</b>	external	external	external	external	external	external	internal
<b>Lubricant</b>	soluble oil	neat oil	soluble oil	soluble oil	neat oil	neat oil	soluble oil
<b>Machine type</b>	machining centre	turning centre	machining centre	turning centre	machining centre	turning centre	machining centre
<b>v<sub>c</sub> [m/min]</b>	10	8	8	5	6	6	12
<b>Tool life</b>	1250 threads	640 threads	730 threads	480 threads	970 threads	1680 threads	6350 threads

#### Selected machining results for thread milling

<b>Guhring no.</b>	3526	3541
<b>Diameter</b>	M8	M24
<b>Coating</b>	TiCN	TiCN
<b>Material group</b>	stainless steel	stainless steel
<b>Material description</b>	X5CrNi13 4 1.4301	X6CrNiMoTi17 12 2 1.4571
<b>Thread depth [mm]</b>	16.0	30.0
<b>Hole type</b>	blind hole	blind hole
<b>Cooling</b>	internal	internal
<b>Lubricant</b>	soluble oil	soluble oil
<b>Machine type</b>	machining centre	turning centre
<b>v<sub>c</sub> [m/min]</b>	60	60
<b>f<sub>z</sub> [mm]</b>	0.05	0.08
<b>Tool life</b>	1140 threads (climb milling)	1350 threads (climb milling)



## Threading tools for stainless steels

Standard	Type	Tolerance zone	Tool description and application	Tool material	Surface finish	Diameter range	Guhring no.
<b>Taps</b>							
<b>for through holes</b>							
DIN 371	VA/B	ISO 2 / 6H		HSS-E	TiN	M3 - M10	2086
<b>Taps</b>							
<b>for blind holes</b>							
DIN 371	VA R15/C	ISO 2 / 6H		HSS-E	TiN	M3 - M10	2896
DIN 371	VA R40/C	ISO 2 / 6H		HSS-E PM	TiN	M3 - M10	59
DIN 371	VA R50	6HX		HSS-E PM	TiN	M3 - M10	761
DIN 371	VA R50	6HX		HSS-E PM	TiCN	M5 - M10	1139
<b>Fluteless taps</b>							
<b>for through holes and blind holes</b>							
~DIN 371	N/C	6 HX		HSS-E PM	TiN	M3 - M10	322
~DIN 371	N/C	6 HX		solid carbide	TiCN	M3 - M10	1972
<b>Thread milling cutters</b>							
<b>for through holes and blind holes</b>							
Guhring standard	TMC SP			solid carbide	TiCN	M3 - M20	3526
Guhring standard	TMU SP			solid carbide	TiCN	≥14 - ≥30	3541

## Modular tools for stainless steels

### Made to measure - modular tools from Guhring

Guhring manufactures modular tools individually tailored to your specific machining task. Our aim is to solve complex machining tasks with intelligent tooling solutions as simply and quickly as possible, in order to save your production time and costs.

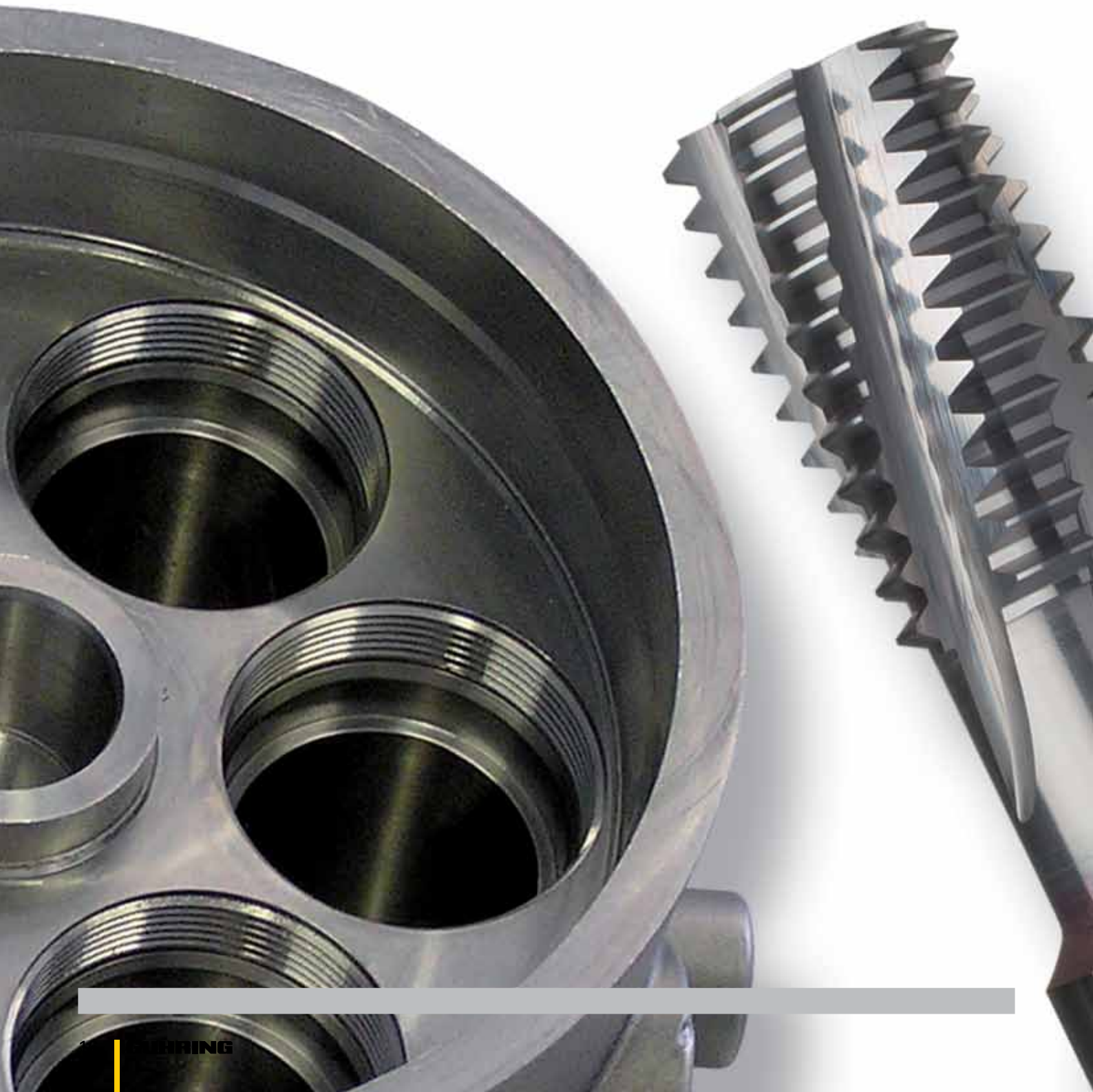





# GUHRING

## Guhring oHG

P.O. Box 10 02 47 · D-72 423 Albstadt  
Herderstr. 50-54 · D-72 458 Albstadt  
Telephone: +49 74 31 17-0  
Fax: +49 74 31 17-2 79  
www.guehring.de

## Our service centers

- |   |                      |                 |                     |
|---|----------------------|-----------------|---------------------|
| 1 Germany<br><i>Albstadt<br/>Berlin<br/>Chemnitz<br/>Eisenach<br/>Geislingen<br/>Gosheim<br/>Mindelheim<br/>Saarbrücken</i> | 2 Australia          | 12 Korea        | 22 Taiwan           |
| 3 Brazil - Diadema  | 3 Brazil - Diadema   | 13 Mexico       | 23 Thailand         |
| 4 Brazil - Joinville  | 4 Brazil - Joinville | 14 Netherlands  | 24 Czech Republic   |
| 5 China   | 5 China              | 15 Austria      | 25 Turkey           |
| 6 France  | 6 France             | 16 Poland       | 26 Hungary          |
| 7 Great Britain   | 7 Great Britain      | 17 Rumania      | 27 USA - Brookfield |
| 8 India   | 8 India              | 18 Russia       | 28 USA - New Hudson |
| 9 Indonesia   | 9 Indonesia          | 19 Sweden       | 29 Vietnam          |
| 10 Italy  | 10 Italy             | 20 Spain        | 30 White Russia     |
| 11 Japan  | 11 Japan             | 21 South Africa |                     |



No liability can be accepted for printing errors or technical changes of any kind.  
Our Conditions of Sale and Terms of Payment apply. Available on request.